

Morgan

SPA OWNER'S MANUAL

Operation and Care
For Your Spa

*OVER 45 YEARS
IN BUSINESS*

Spas manufactured between:
November 2005 to Present

DISCLAIMER:

The information in this manual is accurate to the best of Morgan Buildings and Spas, Inc.'s knowledge. However, Morgan assumes NO responsibility for errors or omissions. Nor is any liability assumed for damages resulting from use of the information contained herein.

Congratulations on your purchase of a Morgan Spa. Your Owner's Manual provides installation, operation and maintenance instructions. Please review it and keep it for future reference.

Owner's Record Information

Date Purchased _____

Purchased From _____

Installed By _____

Serial Number _____

Model Number _____

Contact Phone # for Service Repairs to Spa _____

Corporate Office:
Morgan Buildings & Spas, Inc.
P.O. Box 660280
Dallas, Texas 75266-0280
Phone: (972) 864-7300

REVISION: NOVEMBER 2005

TABLE OF CONTENTS

❖ SECTION 1: Installation & Safety Instructions	
➤ Introduction	1A
➤ Important Safety Instructions	1A
➤ A Word About Spa Fun & Safety	1C
➤ Spa Location	1C
➤ Initial Fill & Start-Up	1D
➤ Spa Frog In-Line System	1D
▪ Installing Cartridges	1E
▪ Adjusting/Replacement of Cartridges	1E
➤ Warning...For Your Safety (Risk of Electrical Shock)	1F
➤ Field Wiring Diagrams	
▪ Newport 325 & Oceanside 325 Model Spas	
• 120V/240V Convertible Digital Control System	1G
▪ Morgan Digital 240V Single Pump System — Non-Convertible Pack	1G
▪ Morgan Digital 240V 2-Pump System — Non-Convertible Pack	1G
Field Wiring of GFCI (Example)	1H
❖ SECTION 2: Morgan Digital Control Systems	
➤ Controls	
▪ Start the Pump	2A
▪ Start the Blower	2A
▪ Turn on the Light	2A
▪ Changing the Water Temperature	2B
▪ Activate the Standby Mode	2B
➤ Programming	2B
➤ Overheat Protection	2B
➤ Problems & Corrective Actions	2B
❖ SECTION 3: Morgan II Deluxe Digital Single Pump and Dual Pump Control System	
➤ Pump Switch for Single System	3A
➤ Pump Switch for Dual System	3A
➤ Warm & Cool Button	3A
➤ Quiet/Stand-by Mode Button	3A
➤ Blower Button	3B
➤ Light Button	3B
➤ LED Lights (color change)	3B
➤ Program Keypad	3B
▪ Time of Day	3B
▪ Filter Cycle State Time & Duration	3B
▪ Temperature Units	3C
▪ Panel Lock	3C
▪ Panel Unlock	3C
▪ Store Settings in Memory & Return to Normal Mode	3C
▪ Automatic Return to Normal Mode	3C
➤ Economy Keypad	3C
➤ Other Features:	
▪ Auxiliary Keypad	3D
▪ Alternating Temperature/Time Display	3D
▪ Ozone Output	3D
▪ Smart Winter Mode	3D
▪ Invert Screen	3D
▪ Power Up Detection	3D
➤ Problems & Corrective Actions	3D
➤ Trouble Shooting Guide	3E

❖ **SECTION 4: Air Controls, Jets & Other Features**

- Jets
 - Air Action Jet 4A
 - Air Injector Jet 4A
 - Cyclone Jets (Large and Mini) 4A
 - Multifoot Massage Jet 4A
 - Ozone Jet 4A
 - Flutter Blaster Jet 4A
 - Ultramassage Luxury Jet 4A
 - Volcano Jet 4A
 - Mini-Flutter Blaster Jet 4A
 - Mini-Luxury Directional Jet 4A
 - Non-Adjustable Pulsator Euro Jet 4A
 - Non-Adjustable Directional Euro Jet 4B
- Other Features
 - Box Skimmer w/Large Grate 4B
 - Strip Skimmer 4B
 - Power Collar Valves 4B
 - Air Controls 4B
 - Waterfalls 4B
 - Control Valves for Monaco 850 Style Spa 4B

❖ **SECTION 5: Maintaining Your Portable Spa
& Protecting Your Spa In Winter Months**

- Recommended Maintenance Schedule for Your Spa 5A
- Cleaning & Changing Your Filter Cartridge 5B
- How to Drain & Clean Your Spa 5B
- Care & Upkeep of Your Spa
 - The Wood Cabinet 5C
 - Acrylic Finish 5C
 - Spa Cover 5C
 - Decks 5D
- Protecting Your Spa in Winter Months 5D
- Moving Your Spa 5D

❖ **SECTION 6: Spa Care / Chemical Maintenance /
Ozonators / Spa Accessories**

- Regular Spa Care 6A
- The Importance of Chemical Balance 6A
- A Simple Overview of the Spa Chemistry & Disinfecting 6B
- The Importance of pH Control 6B
- Ozonators
 - Sanitizing with Ozone 6B
 - Spa Maintenance with Ozone 6B
- Spa Accessories 6C
- Trouble Shooting Guide 6D

❖ **SECTION 7: Schematics (All Power Packs)**

- Single Pump / Dual Pump 240 7A
- 120 / 240 Convertible Pack 7B
- 220V Pack No Blower 7C

SECTION 1

INSTALLATION and SAFETY INSTRUCTIONS

INTRODUCTION

The Morgan equipment pack and spa incorporates the finest components available, assembled in a manner designed to provide maximum enjoyment, ease of operation and years of trouble-free service.

Please read your owner's manual very carefully and thoroughly. Keep it in an easily-accessible place, so you are able to refer to it whenever you use your spa. The following pages contain complete, detailed instructions and precautions regarding the use, care and maintenance of your hot water product.

IMPORTANT SAFETY INSTRUCTIONS FOR ELECTRICAL EQUIPMENT

When installing and using this electrical equipment, basic safety precautions should always be followed including the following:

1. READ AND FOLLOW INSTRUCTIONS.

2. **WARNING** — To reduce the risk of injury, **do not permit children to use this product unless they are supervised at all times.**

3. A wire connector is provided on this unit to connect a minimum NO. 8 AWG (8.4mm²) solid copper conductor between this unit and any metal equipment, metal enclosures of electrical equipment, metal water pipe, or conduit within 5 feet (1.5m) of the unit.

4. **DANGER** — Risk of Injury.

- ✓ Replace damaged cord immediately.
- ✓ Do not bury cord.
- ✓ Connect to a grounded, grounding type receptacle only.

5. **WARNING** — All 120V models are provided with a ground fault circuit interrupter

located on the power cord. The GFCI must be tested before each use. Connect the plug to the power supply, and with unit operating, push the test button. The unit should stop operating and the reset button should appear. Push the reset button. The unit should now operate normally. If the interrupter fails to operate in this manner, there is a ground current flowing indicating the possibility of an electric shock. Disconnect the plug from the receptacle until the source of the breakdown has been identified and corrected.

6. **DANGER** — To avoid risk of accidental drowning extreme caution must be exercised to prevent unauthorized access by children. To avoid accidents, ensure that children cannot use this spa unless they are supervised at all times.

7. **DANGER** — Risk of Injury.
The suction fittings in this spa are sized to match the specific water flow created by the pump. Should the need arise to replace the suction fittings or the pump, be sure that the flow rates are compatible. Never operate spa if the suction fittings are broken or missing. Never replace a suction fitting with one rated less than the flow rate marked on the original suction fitting.

8. **DANGER** — Risk of Electric Shock.
Install at least 5 feet (1.5m) from all metal surfaces. As an alternative, a spa may be installed within 5 feet of metal surfaces if each metal surface is permanently connected by a minimum No. 8 AWG (8.4mm²) solid copper conductor to the wire connector on the terminal box that is provided for this purpose.

9. **DANGER** — Risk of Electric Shock.
Do not permit any electric appliances, such as a light, telephone, radio or television, within 5 feet (1.5m) of a spa.

10. **WARNING** — To Reduce the Risk of Injury:

- ✓ The water in a spa should never exceed 40°C (104°F). Water temperature between 38°C (100°F) and 40°C (104°F) are considered safe for a healthy adult. Lower water temperatures are recommended for young children and when spa use exceeds 10 minutes.

A WORD ABOUT SPA FUN AND SAFETY

The calming effect of your spa, in combination with the effects of alcohol and/or drugs, is a dangerous combination which can induce unconsciousness that can lead to drowning in the spa water. It is critical that you understand the serious danger created by this combination, and DO NOT use the spa under the influence of alcohol and/or drugs.

MORGAN spas provide year-round enjoyment. However; YOU are responsible for the maintenance and sensible use of a MORGAN spa. For the most fun and safety, be sure you and your family members review this safety manual completely. Keep it on hand for future reference or pass it along to new owners. **MORGAN recommends that you follow these safety precautions:**

- ✓ Do not use the spa when pregnant, if you suffer from heart disease or high/low blood pressure unless you have obtained the approval of a medical doctor.
- ✓ If you are taking medication (including, without limitation, anticoagulants, antihistamines, vasoconstrictors, basodilators, tranquilizers, narcotics, hypnotics, or stimulants) you should contact a medical doctor before using the spa.
- ✓ Do not use the spa when under the influence of alcohol or other drugs.
- ✓ Persons with long hair should wear a bathing cap when using the spa and small children with long hair and/or loose clothing should never be allowed to use the spa. Hair or clothing could be sucked into skimmers, suction fittings or drains causing serious injury or death.
- ✓ Using the spa alone is not recommended.
- ✓ Always check the water temperature before using the spa. Make sure the water temperature is never higher than 104°F (40°C). Higher temperatures could result in serious bodily injury or death.

You don't have to take fun out of spa ownership. Your knowledge of safety precautions and good sense minimizes risks. One individual must assume responsibility for supervising the spa or hot tub. This person should be thoroughly familiar with the contents of this manual and be responsible for enforcing "house rules" for your spa or hot tub.

SPA LOCATION

Morgan DOES NOT assume any responsibility of damage caused by water leakage or weight of the spa. Selecting the proper location for your spa is very important.

If not installed on concrete slabs, make sure ground condition will support blocking points. If settling does occur the spa will need to be re-leveled. Failure to maintain a level spa could damage your spa and Morgan DOES NOT assume responsibility for any damages to your spa if this occurs.

Blocking diagram shown is used for all spa types EXCEPT the Monaco spa. Monaco spas require 2 center blocks.

Outside perimeter blocks are 8"x16" blocks and center block(s) are 16"x16"x4" block(s).

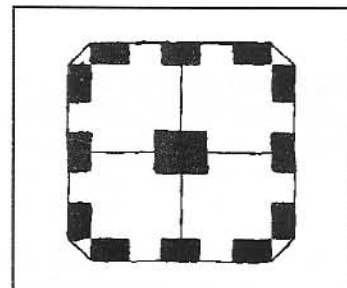

If your spa is to be located **OUTDOORS**, consider the following:

- ✓ Local codes pertaining to fencing.
- ✓ Local electrical codes.
- ✓ View from the house.
- ✓ Wind direction and sun exposure.
- ✓ Location relative to trees (falling leaves and shade).
- ✓ Dressing and bathroom locations.
- ✓ Storage area for maintenance equipment and chemicals.
- ✓ Landscaping and night time lighting.
- ✓ Sprinkler systems already installed in yard.
- ✓ Location to facilitate adult supervision.
- ✓ A level, hard surface capable of withstanding weight in excess of 4,000 pounds (larger spa models when filled with water).
- ✓ Run-off from roof.

If your spa is to be located **INDOORS**, consider the following:

- ✓ Indoor spas develop high humidity. Removing this humidity can be accomplished by cross ventilation fans, oversized dehumidifiers, or both.
- ✓ Chemicals will evaporate off the water surface. This may cause corrosion to certain metals found in home hardware and appliances.
- ✓ Floor drains should be provided to carry off water splashed from the spa.
- ✓ Walls, ceilings, woodwork, etc., should be made from materials capable of withstanding high humidity.
- ✓ Be sure the supporting structure is capable of withstanding the weight of the spa which is in excess of 4,000 pounds (larger spa models when filled with water).
- ✓ Be sure the surface on which spa is to be put is smooth and level.

INITIAL FILL & START UP

IMPORTANT NOTE

READ AND FOLLOW ALL INSTRUCTIONS ON THE CHEMICAL LABELS. ONCE THE SPA HAS BEEN FILLED AND IN USE NEVER OPEN THE FILTER OR FROG CAP WHILE THE JETS ARE ON.

- ✓ **Turn off all electrical power to the spa.**
- ✓ The equipment pack must never be operated without water in the spa, as serious damage to the heater and/or pump could result.
- ✓ Fill your spa with normal tap water. DO NOT USE WATER FROM ANY TYPE OF WATER SOFTENER.
- ✓ Fill the spa with water to the recommended level, which is approximately 5 inches from the top.
- ✓ Open valves. It is important to run the pump for several minutes to remove all the air from the system. If after several minutes water fails to flow through jets, refer to Troubleshooting Guide.
- ✓ Add Morgan Metal Protector and Stain Preventor. **All chemicals should be added with the spa in the blower mode ONLY with blower on high speed AND/OR pump running.**
- ✓ Add Morgan Chlorine Granules (2 ozs.) to achieve a residual level of 1-2 ppm.
- ✓ Test your water with the Test Strips, which you will find in your chemical start-up kit. Check the water's total alkalinity and pH (both should be 7.2 to 7.6) and adjust to proper level. Add pH up or down accordingly to reach the correct level.
- ✓ Refer to the Digital Control Section in the manual to set filtration and temperature levels.
- ✓ Once the water has been balanced according to the recommended guidelines provided **AND** the spa water reaches the proper operating temperature you can insert the Mineral and Bromine Cartridges.

Water Balance Guidelines

pH:	7.2-7.8
Total Alkalinity	60-120 ppm
Free Bromine	1.0-2.0 ppm
Chlorine*	1.0-2.0 ppm

(*ONLY @ startup)

BEFORE the initial installation OR replacing the mineral or bromine cartridges YOU MUST FIRST SHUT THE SYSTEM OFF BY PUTTING THE SPA IN STAND-BY MODE. For instructions on how to place your spa in stand-by mode (and depending on the type of Digital Control system your spa has) refer to Sections 2 or 3 of your Spa Owner's Manual. Once the system has been placed in stand-by mode you will then follow the same procedures for installing or replacing the cartridges as outlined.

Initial Installation of Cartridges Into the Holder

CONGRATULATIONS! Your Morgan spa comes with the most advanced, revolutionary sanitation system available today. When using your spa with the unique SPA FROG Mineral Cartridge with the SPA FROG Bromine Cartridge you'll enjoy your spa more with LESS work and LESS bromine.

Less work because:

- Minerals continuously work to control bacteria for 4 full months.
- Cartridges last longer to eliminate daily maintenance.
- Cartridges are pre-filled for no measuring or mess.
- Simply adjust to your setting and relax for weeks.

Less Bromine because:

- With minerals in the water, bromine use is cut by up to

50%.

- Bromine lasts longer: 2-4 weeks on a 350-gallon spa with average use.
- With minerals and low levels of bromine, the water feels softer.
- The system reduces odors and leaves the water crystal clear.
- SPA FROG has the only minerals that work with bromine.

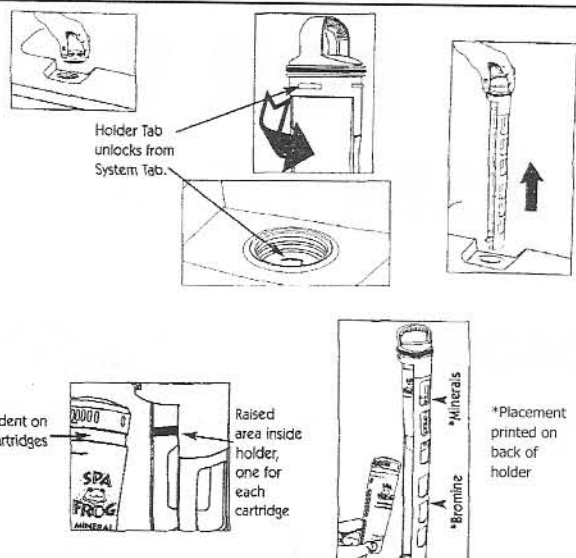
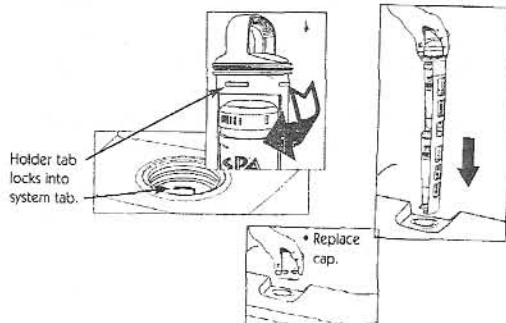
<ul style="list-style-type: none"> • TO INSTALL remove the Spa Frog Mineral and Bromine Cartridges from packaging. Open cap of Spa Frog In-Line System and set aside. • Unlock holder by turning it (counterclockwise) and pull it out. • After adjusting both cartridges (see adjustment instructions below), snap the Mineral Cartridge into the area marked "Minerals" (top portion) and the Bromine Cartridge into the area marked "Bromine" (bottom portion) making sure to line up the indentation at the top of the cartridges with the raised areas on the holder. 	 <p>Holder Tab unlocks from System Tab.</p> <p>Indent on cartridges</p> <p>Raised area inside holder, one for each cartridge</p> <p>*Minerals</p> <p>*Bromine</p> <p>*Placement printed on back of holder</p>
<ul style="list-style-type: none"> • Slowly insert holder into system. When lowering holder, line up holder tabs between systems tabs. Push down until holder tabs go past system tabs and turn holder to the right (clockwise) until it stops. To ensure a locked position, attempt to pull holder back up. If it stays in place, the lock is secure. • Replace cap. • Take spa out of Stand-By mode. 	 <p>Holder tab locks into system tab.</p> <p>• Replace cap.</p>

Adjusting/Replacing Cartridges

The same procedures will be following for replacing the mineral and bromine cartridges as outline under the installation procedures.

> Mineral Cartridge

Open Mineral Cartridge wide open to setting #6 (see diagram @ right) by holding the top of the unit and turning the bottom counterclockwise until the #6 appears in the setting window. The Mineral Cartridge must be replaced every 4 months. For ease in remembering when to replace the Spa Frog Mineral Cartridge it is recommended you change the Spa Frog Mineral Cartridge every time you drain and fill your spa, which is every 90 to 120 days.

> Bromine Cartridge

As every spa is different, finding the right setting for the Bromine Cartridge may require monitoring your usage for the first few weeks. Begin with setting #3 (see diagram @ right) and monitor bromine levels daily for the first week or so, adjusting the cartridge as needed until a 1-2 ppm level has been achieved. To adjust cartridge, remove the system and turn to the next highest setting if the bromine level is too low, or the next lower setting if the bromine level is high. Adjust by 1 increment per day. On most spas, it will last between 2 and 4 weeks. Always maintain 1-2 ppm bromine level. **NOTE:** the more you use the spa, the greater the setting to achieve a constant 1-2 ppm. If usage decreases, the setting may be lowered.

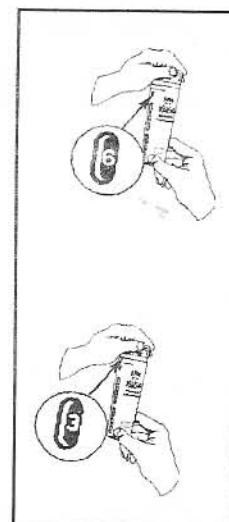

- ✓ Since excessive water temperature has a high potential for causing fetal damage during the early months of pregnancy, pregnant or possibly pregnant women should limit spa water temperature to 38°C (100°F).
- ✓ Before enter a spa, the user should measure the water temperature with an accurate thermometer since the tolerance of water temperature regulating devices varies.
- ✓ The use of alcohol, drugs, or medication before or during spa use may lead to unconsciousness with the possibility of drowning.
- ✓ Persons suffering from obesity or with a medical history of heart disease, low or high blood pressure, circulatory system problems, or diabetes should consult a physician before using a spa.
- ✓ Persons using medication should consult with a physician before using a spa since some medications may induce drowsiness while other medications may affect heart rate, blood pressure, and circulation.
- ✓ Do not allow your spa temperature to go above 40°C (104°F). Immersion in water above this point and prolonged immersion in water even at lower temperatures can cause hypothermia.

WARNING

The use of alcohol, drugs or medication can greatly increase the risk of fatal hyperthermia.

HYPERTHERMIA

The cause, symptoms, and effects of hyperthermia may be described as follows: hyperthermia occurs when the internal temperature of the body reaches a level several degrees above the normal body temperature of 98°F. The symptoms of hyperthermia include an increase in the internal temperature of the body, dizziness, lethargy, drowsiness, and fainting.

The effects of hyperthermia include: (1) failure to perceive heat, (2) failure to recognize the need to exit spa or hot tub, (3) unawareness of impending hazard, (4) fetal damage in pregnant women, (5) physical inability to exit the spa or hot tub, and (6) unconsciousness resulting in the danger of drowning.

WARNING

DO NOT EXCEED

104°F

**Check Water Temperature
Before Entering Spa**

11. **SAVE THESE INSTRUCTIONS.**

W A R N I N G

FOR YOUR SAFETY RISK OF ELECTRICAL SHOCK

MORGAN REQUIRES THAT YOUR SPA BE WIRED BY A LICENSED ELECTRICIAN.

GFCI PROTECTION IS PROVIDED ON ALL 120 VOLT OPERATED SPAS BY MEANS OF A CORD END GFCI. PLUG THIS CORD END GFCI DIRECTLY INTO A 15 AMP DEDICATED CIRCUIT.

NO GFCI PROTECTION IS PROVIDED FOR 240 VOLT OPERATED SPAS. YOUR ELECTRICIAN MUST PROVIDE GFCI PROTECTION. YOUR SPA MUST BE GROUNDED IN ACCORDANCE WITH THE NATIONAL ELECTRIC CODE.

(Revised: 11/01/05)

FIELD WIRING DIAGRAMS

DANGER - RISK OF ELECTRIC SHOCK

NOTE: See page 1H for example of Field Wiring of GFCI.

**NEWPORT 325 &
OCEANSIDE 325 MODEL SPAS
120/240V Morgan Convertible
Digital Control System**

120 Volt Wiring Diagram

When wiring for 120V, this unit **MUST** be wired with a 120V, 15AMP GFCI power cord. This must be plugged into a 120V, 15AMP receptacle. No other device may be on this circuit. Plug into an approved grounding type receptacle **ONLY**. **DO NOT** attempt to alter the plug or use converters to fit other receptacle configurations.

**120 Volt Wiring Diagram
For 120/240V Convertible Digital Pack**

Volts 120; Amps 15, 2 Wire Plus Ground
Conductor Ampacity 20 Amps
Circuit Breaker 20 Amps
1 Phase, 60 Hz

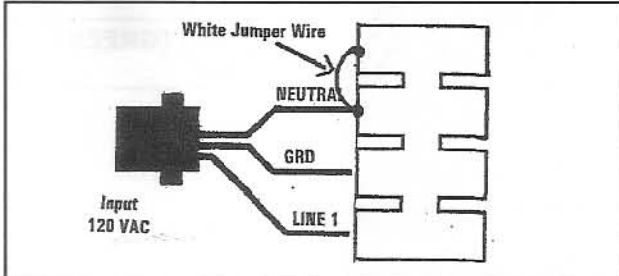

**240 Volt Wiring Diagram
(NOTE: GFCI NOT PROVIDED WITH UNIT)**

Conversion to 240V: conversion to 240V must be done by a licensed electrician **ONLY**. To wire the system for 240V operations, supply input power as indicated in the figure. The 120V power cord that came with the unit must be removed and discarded when the unit is converted to 240V.

240 Volt Wiring Diagram
Volts 240; Amps 39, 3 wire Plus Ground
Conductor Ampacity 50 Amps
Ground Fault Circuit Interrupter, 50 Amps
1 Phase, 60 Hz

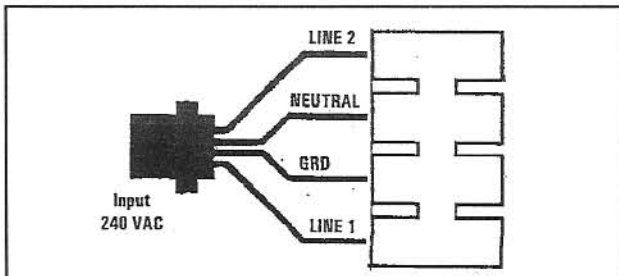

**For Morgan Digital 240
Single Pump System
Non-Convertible Pack**

240 Volt Wiring Diagram

240V Deluxe Digital Single Pump
240V Digital Single Pump

**240 Volt Single Pump System
(NOTE: 50AMP GFCI NOT PROVIDED WITH UNIT)**

Volts 240, Amps 40, 3-Wire Plus Ground
Digital Control System
Conductor Ampacity 50 Amps
Ground Fault Circuit Interrupter
50 Amps, 1 Phase, 60 Hz

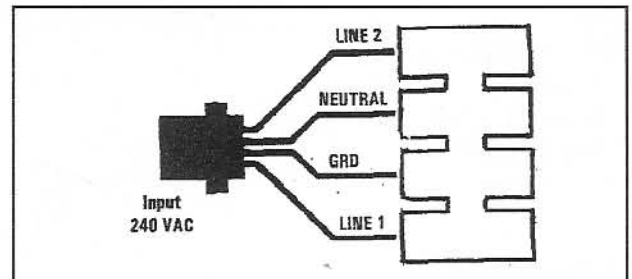

**For Morgan Digital 240 2-Pump System
Non-Convertible Pack**

**240 Volt 2-Pump System
(NOTE: 60AMP GFCI IS PROVIDED WITH UNIT)**

These models require 60A GFCI breakers four wire sized accordingly, which includes a neutral and ground.

Volts 240, Amps 48, 2-Wire Plus Ground
Conductor Ampacity 60 Amps
Ground Fault Circuit Interrupter
60 Amps, 1 Phase, 60 Hz

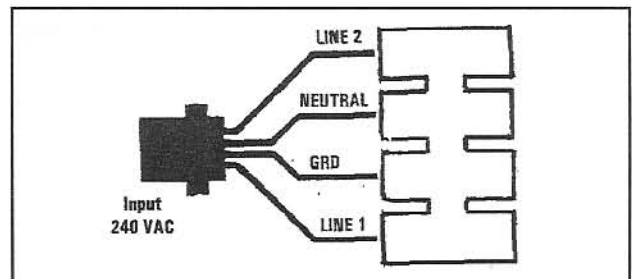

Field Wiring of GFCI (Example)

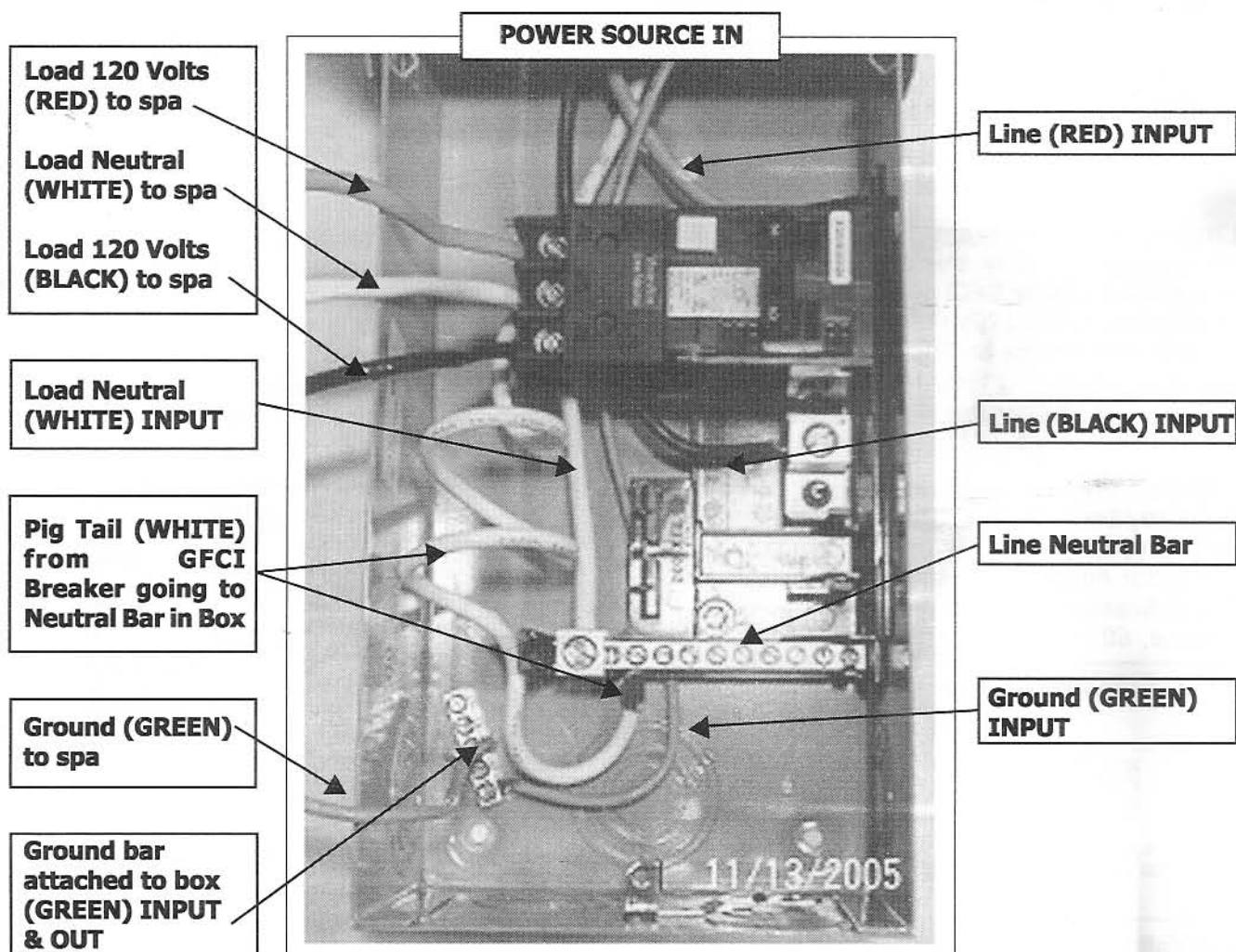
DANGER - RISK OF ELECTRIC SHOCK

IMPORTANT NOTE: Installation of this GFCI — Circuit Breaker, including ampere sizing and selection of conductor size and type — **MUST** be accomplished by a qualified electrician in accordance with the National Electrical Code and all federal, state and local codes and regulations in effect at the time of installation.

NOTE THIS: The white neutral wire from the back of the GFCI **MUST** be connected to an incoming line Neutral. The internal mechanism of the GFCI requires this neutral connection. Without it, the GFCI WILL NOT work.

SECTION 2 MORGAN DIGITAL CONTROL SYSTEMS

Morgan Digital Single Pump 240V Control System (No Blower)

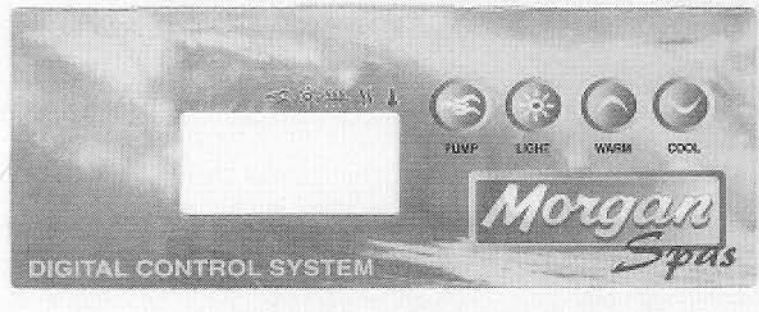

Morgan Digital Single Pump 240V Control System (With Blower)

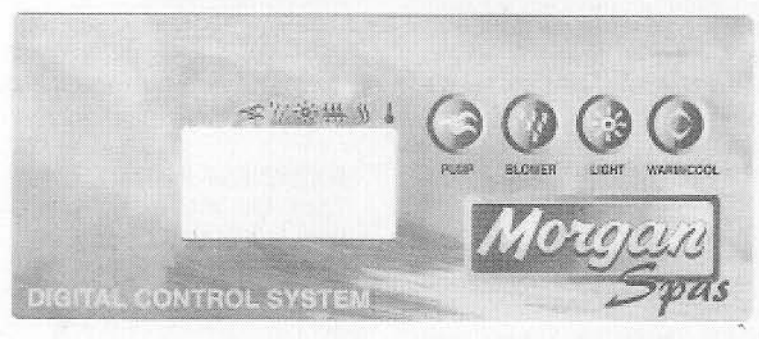

Morgan Convertible Digital Control System

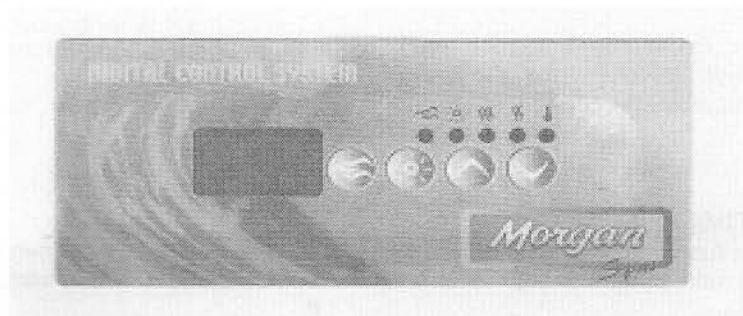

CONTROLS

Start Pump 1 (For Single Pump/Convertible Pump Systems)

Press on the Pump 1 key to turn Pump 1 on. A second press will change Pump 1 speed. A third press will turn Pump 1 off. A built-in timer will shut Pump 1 off 20 minutes after it has been started unless you do so manually. The Pump 1 On Light indicator will be lit when the Pump 1 is running.

Start the Blower (blower many not be featured on all digital control systems)

Press on the Blower key to turn the blower on. A second press will turn blower off. A built-in timer will shut the blower off 30 minutes after it has been started unless you have done so manually. The Blower On icon will appear on the display when the blower is running.

Turn on the Light

Press the Light key to turn the light on. A second press will turn the light off. The light will automatically shut itself off after 2 hours. The Light On icon will appear on the display when the light is on.

Changing the Water Temperature (some units will have either 1 key to represent Warm and Cool or may have 2 keys, one each for the Warm and Cool key)

The Warm and Cool arrow key(s) is used to set the temperature of the water. Keeping the pressure on the key will increase (or decrease) the current temperature setting. The new and desired temperature setting will remain for 5 seconds on the LED display as a confirmation of its new value.

The Set Point triangular icon appearing on the display tells you that the temperature shown is the desired, and not the actual, temperature of the water. The temperature can be adjusted in 1° increments from 59° to 104°F (or from 15° to 40°C).

Water heater automatic start: when the water temperature is 1°F lower than the set point, the heater will be turned on until the water temperature reaches the set point plus 1°F. The Heater On triangular icon will appear on the display when the heater is on.

Activate the Standby Mode

To activate the Standby Mode, press the Pump key and hold for 5 seconds. The system will turn all outputs off for 30 minutes and the SBY message will appear on the display. Press any key to return to the normal mode.

PROGRAMMING

Program the Duration of the Filtration Cycles

The system will automatically perform two filtering cycles per day, 12 hours apart. During a cycle, the pumps will be activated for a predetermined number of hours. To set the duration of the filtering cycle (the amount of time the pumps will be on), follow this procedure:

- ✓ Press the Light key and hold for 5 seconds. The display will show a value that represents the duration of the filter cycle in hours.
- ✓ Use the Warm and Cool arrow key(s) to change the number of hours. 0 = no filtration, 12 = continuous filtration.
- ✓ When the desired setting is displayed, press the light key again. The filter cycle will start. The Filter On triangular icon will appear on the display when a filtration cycle is on.

Note that after a power failure, the filter cycle duration will return to its default value (6 hours). In this case, the first filter cycle will start 12 hours after the power has been

restored. Note also that to prevent excessive water temperature caused by too long filtration cycles, after three (3) hours the system will cancel a filter cycle if the water temperature raises more than 2°F above the set point. In this case, the filter cycle triangular icon will flash on the display.

OVERHEAT PROTECTION

To prevent excessive water temperature build-up during filter cycle in hot water, if water temperature exceeds Set Point by over 2°F (1°C) for more than 3 hours, the system will shut down the filter cycle and "Filter" indicator will flash for the remainder of the cycle repeatedly as follows: 3 short flashes followed by a longer flash. If water temperature cools to 1°F (0.5°C) above Set Point before scheduled end of the cycle, filter cycle will resume for remaining time. During filter cycle if a pump, blower and/or light are turned on, the cycle will be suspended until 40 minutes after the last accessory has been turned off. During this time the "Filter" indicator will flash.

PROBLEMS & CORRECTIVE ACTIONS

The Heater On triangular icon flashed on the display when the pump is on high speed. Not a bug but a feature! The system is turning the heater OFF when the pump is in high speed to limit the amount of electrical current drawn.

The pump starts by itself for 1 minute on several occasions and the filter cycle triangular icon is flashing on the display when that happens. Not a bug but a feature! The Smart Winter Mode of the spa pack protects the spa from the cold by turning on the pump for 1 minute several times a day to prevent the water from freezing in the plumbing.

 Pumps have started up for one minute on several occasions and "Filter Cycle" icon is flashing. <i>This isn't a bug, it's a feature!</i> Our Smart Winter Mode protects your system from the cold by automatically turning pumps on for one minute several times a day to prevent water from freezing in pipes. If the display is flashing, then a power failure has occurred. Press any key to reset the system, then reprogram all desired parameters.	112° Water temperature is flashing. Water temperature in the spa has reached 112°F (44°C). DO NOT ENTER THE WATER. Allow the water to cool down. The system will reset itself when water reaches 109°F (43°C). Call your local sales location if problem persists.	... 3 flashing dots are displayed. A problem has been detected. DO NOT ENTER THE WATER. Check and open water valves. Clean filters if necessary. Check water level. Add water if needed. Shut power off and power your spa back up again to reset the system AND call your local sales location if problem persists.
--	---	--

SECTION 3

MORGAN DELUXE DIGITAL SINGLE PUMP CONTROL SYSTEM MORGAN DELUXE DIGITAL DUAL PUMP CONTROL SYSTEM

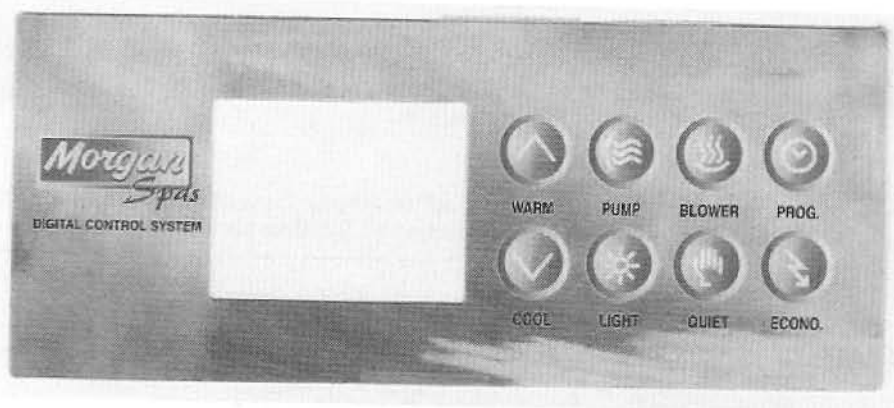

PUMP SWITCH – for single pump system

This key is used to control the pump #1 output. Successive presses of this key will turn on the pump in the following sequences:

- Pump #1 low only
- Pump #1 high only
- Pump off, unless spa is in an active filter cycle

PUMP SWITCH – for dual pump system

This key is used to control the pump #1 and pump #2 outputs. Successive presses of this key will turn on the pumps in the following sequences:

- Pump #1 low only
- Pump #1 high only
- Pump #1 high and Pump #2 high
- Pump #2 high only
- Both pumps off, unless spa is in an active filter cycle

A built-in 30 minute timer will shut the pump(s) off, unless the user does so manually, when a pump is active (#1, #2, or both), the corresponding icon on the display will be on too. Note that in the case of Pump #1 Low, the Pump #1 icon will blink. Note that if there is a call for Heat, or if there is an active Filter Cycle, Pump #1 cannot be turned off, it will remain ON in Low speed.

WARM & COOL BUTTON

These keys are used to set the temperature of the water and program some system functions. As soon as the user presses one of these keys, the display will show the current set point and will keep showing it for five (5) seconds after releasing the key. Pressing the keys will either increase or decrease the set point. The set point logo on the display tells the user if the display shows the current set point or the actual temperature of the water.

The water temperature can be adjusted in one (1) degree increments from 59° to 104°F (or from 15° to 40°C). When the water temperature is 1°F (0.5°C) lower than the set point, the heater will come on until the water temperature reaches the set point plus 1°F (0.5°C). The heater logo on the display will blink on when the heater is actually turned on.

QUIET/STAND-BY BUTTON

This key is used to manually shut off all outputs (Pump #1, Pump #2 and Blower). However, if there is a call for Heat, or an active Filter Cycle, Pump #1 will remain on in Low speed.

If the key is pressed and held for 5 seconds, the spa will enter the standby mode. In this mode, all outputs are off (including Pump #1, even if a call for Heat is present, or a Filter Cycle is active) and the display will show "Stby". This mode allows the user to change the spa's filter. The user then presses any key to exit the standby mode and the spa resumes normal operation. Should the user forget to exit the standby mode, the spa will automatically resume normal operation after 30 minutes.

BLOWER BUTTON

When the Blower keypad is pressed shortly, it will turn on the blower in high speed. When pressed shortly a second time, it will turn off the blower. If the blower keypad is held (when the blower is on), the blower's speed will continuously vary from High to Low, and then back to High. A built-in timer will shut the blower off after 30 minutes if it hasn't been shut off automatically. When the blower is on, the blower logo on the LCD display will also be on.

LIGHT BUTTON

Successive presses of this key will turn the Light on and then off. The light will automatically shut off after 2 hours. When the light is on, the light logo on the display will also be on (it will blink in low intensity).

LED LIGHTS (color change)

If your spa is equipped with an optional LED light button, this button is used to control the light color desired and is operated by the light function button on the control pad. Each time it is turned off and then back on it goes through a different sequence until it goes through all the options.

PROGRAM KEYPAD

This key is used to program 8 functions. These functions are

- Time of Day
- Filter Cycle Start Time
- Filter Cycle Duration
- Auxiliary Light Start Time
- Auxiliary Light Duration
- Temperature Units
- Panel Locks
- Storage of Settings of Memory
- Return to Normal Mode

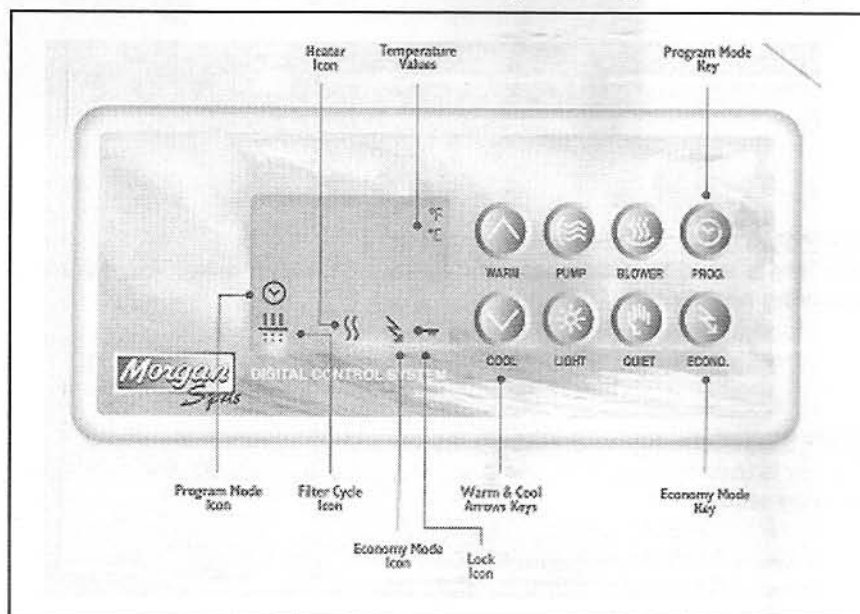

Time of Day

The following is the procedure to set or to modify the time of day.

- » Start the programming mode by pressing the program key for 2 seconds or until program icon appears on the display. The display will show the current time of day.
- » Use the Warm or Cool arrow keys to adjust the current time.

Filter Cycle Start Time & Duration

The filter cycles will have the unit run every day for filtering purposes even if you are not using the spa. The filter cycle begins with a 1-minute purge cycle of the blower and Pump 2; then Pump 1 is activated in low speed for the amount of time you will have programmed. The ozone output is also activated during filter cycles.

To program a filter cycle, you must enter two (2) parameters: the start time of the cycle and the duration of the cycle. If no filtering is required, you must set the duration to 0. The filtering cycle will occur twice a day every 12 hours. If continuous filtering is required, the filter cycle duration must then be set to 12 hours. When a filter cycle is in process, the Filter icon appears on the LCD display.

To set the start time of the cycle:

- ❖ Press a second time on the program key.
- ❖ The display will show FSXX where XX represents the starting hour.
- ❖ Use the Warm or Cool arrow keys to change the starting time.

To set the duration of the cycle:

- ❖ Press a third time on the program key.
- ❖ The display will show FDXX where XX represents the duration in hours.
- ❖ Use the Warm or Cool arrow keys to change the duration.

Temperature Units

The temperature of the water can be displayed in °F or °C. To select the desired measure units, you must follow this procedure:

To select the temperature display units:

- ❖ Press a sixth time on the program key.
- ❖ The display will show TUX where X is either F or C.
- ❖ Use the Warm or Cool arrow keys to change the selection.

Panel Lock

The panel lock function allows you to prevent unauthorized parameter programming of the unit. The basic functions of the spa will remain accessible (pump 1, pump 2, blower and light) but it will not be possible to change the temperature set point, to override the economy mode or to get into the programming mode.

When the panel lock function is on, the Lock icon will appear on the display.

To activate the panel lock function:

- ❖ Press seventh time on the program key.
- ❖ The display will show LOC 0 or LOC 1 depending if the panel lock is on or off.
- ❖ Use the Warm or Cool arrow keys to change the setting.

Panel Unlock

When the keypad has been locked in the programming mode, you must follow this procedure to unlock the keypad:

- ❖ Press the program key. The message "Loc" will appear on the display.
- ❖ Press (in this order) – the Warm arrow key, then the pump key, then the light key.
- ❖ The lock icon will disappear from the display. The system will then return to the normal mode.

If the unlock process takes more than 15 seconds, the unit will return to the normal mode and the keyboard will still be locked.

Store Settings in Memory & Return to Normal Mode

Press an eight time on the program key to store the settings in the system non-volatile memory and to return to the normal mode.

Automatic Return to Normal Mode

At any time during programming, if the user does not touch the keypad for more than 10 seconds, the unit will exit the programming mode and go back to normal display. Any changes done so far are saved.

When the system is in the programming mode, the only keys working are the Program Key, the Warm Key and the Cool key.

ECONOMY KEYPAD

This keypad is used to set the spa Economy mode. There are three (3) available operating modes:

- » **Normal Mode (no economy)** – this mode is the default mode of operation. The heater will always regulate the spa temperature to the desired set point.
- » **Economy Mode #1** – economy mode is always on. In this mode, the heater will regulate the spa temperature to 20°F (11°C) BELOW the desired set point. In this mode, the economy logo is lit on the display.
- » **Economy Mode #2** – this mode is a variant of mode #1. The difference is the period in which the mode is active. Between 4 PM and 9 PM, the heater regulates the spa temperature normally (desired set point). Outside of this 5 hour time period, the heater will regulate as if in economy mode #1 (BELOW desired set point).

To select the wanted economy mode, press the Economy keypad. The display will then show the current mode that is set ('noEC', 'EC 1', or 'EC 2'). Keep pressing the economy keypad until the desired mode is displayed. After approximately five (5) seconds, the new setting is saved and the spa returns to normal time/temperature display.

OTHER FEATURES

Auxillary Keypad (Side Panel)

This keypad has 4 keys, which have exactly the same functionality as the pump, blower, light and the quiet/standby keys on the main keypad. It gives the user the possibility of operating the spa from another location within the spa.



Alternating Temperature & Time Display

Every five (5) seconds, the display normally alternates between the current time and the actual spa temperature.

Ozone Output

This output is turned on during the filter cycle. However, if the spa is being used (pump #1, pump #2, light, or blower outputs are manually turned on), the ozone output will stay off until the spa is not in use anymore.

Smart Winter Mode

This system prevents the water from freezing in the pump plumbing. An onboard sensor continuously checks the ambient air temperature in the pack. If at any time the temperature goes below 60°F the system activates the winter mode for the next 24 hours. In this mode, if the pumps haven't been turned on during the last two (2) hours, the system will start them (see note) for one (1) minute to circulate warmer water in the plumbing. When the pumps are running because of this protective feature, the filter cycle icon on the display will blink.

Note: the pumps will come on according to the following sequence:

- Pump # 1 low for 2 seconds
- Pump # 1 high for the rest of the cycle.
- Pump #2 high, 2 seconds, AFTER pump #1 has gone to high speed.

Invert Screen

To invert the display screen to be seen from inside the spa hold light key down for 5 seconds.

Power-Up Detection

After a power-up, the display will blink until somebody presses a key. This feature is to let the user know that a power failure has occurred and that the onboard clock may need reprogramming (see *Program Switch* description). Normally, the onboard clock can keep the correct time for at least 48 hours during a power failure. Note that a power failure does NOT affect any other programming, only the clock itself may be affected

PROBLEMS & CORRECTIVE ACTIONS

The Heater On triangular icon flashed on the display when the pump is on high speed. The system is turning the heater OFF when the pump is in high speed to limit the amount of electrical current drawn.

The pump starts by itself for 1 minute on several occasions and the filter cycle triangular icon is flashing on the display when that happens. Not a bug but a feature! The Smart Winter Mode of the spa pack protects the spa from the cold by turning on the pump for 1 minute several times a day to prevent the water from freezing in the plumbing.

<p>⏏ ⏏ ⏏</p> <p>Pumps have started up for one minute on several occasions and "Filter Cycle" icon is flashing. <i>This isn't a bug, it's a feature!</i></p> <p>Our Smart Winter Mode protects your system from the cold by automatically turning pumps on for one minute several times a day to prevent water from freezing in pipes.</p> <p>If the display is flashing, then a power failure has occurred. Press any key to reset the system, then reprogram all desired parameters.</p>	<p>112°</p> <p>Water temperature is flashing. Water temperature in the spa has reached 112°F (44°C).</p> <p>DO NOT ENTER THE WATER. Allow the water to cool down. The system will reset itself when water reaches 109°F (43°C).</p> <p>Call your local sales location if problem persists.</p>	<p>...</p> <p>3 flashing dots are displayed. A problem has been detected.</p> <p>DO NOT ENTER THE WATER. Check and open water valves. Clean filters if necessary. Check water level. Add water if needed.</p> <p>Shut power off and power your spa back up again to reset the system and call your local sales location if problem persists.</p>
---	--	---

Trouble Shooting Guide

SYMPTOM	POSSIBLE CAUSE	CORRECTIVE ACTION
Equipment pack does not operate	<p>Tripped GFCI breaker, main panel.</p> <p>Cord end GFCI has tripped.</p> <p>Check display panel for message for trouble shooting.</p>	<p>Reset, if breaker will not reset, call for service.</p> <p>Push "reset". If the GFCI will not "reset", the possibility of shock exists. Call your Morgan representative for repairs. Applies to 120/240V convertible models ONLY.</p> <p>Refer to the Trouble Shooting Guide under Digital Controls.</p>
Low flow of water, reduced jet action.	<p>Clogged filter.</p> <p>Plugged or restricted discharge line or suction line.</p> <p>Water level too low.</p> <p>Partially closed inlet or outlet slide valve.</p>	<p>Clean filter.</p> <p>If obstruction is not visible, contact your Morgan representative.</p> <p>Add water.</p> <p>Make sure the handles of the slide valve are pulled out all the way.</p>
Pump leaks at shaft.	<p>Bad seal.</p>	<p>Contact your Morgan representative.</p>
Equipment pack works, but heater does not work.	<p>Equipment pack is not receiving 240V but wired for 240V.</p> <p>Temperature set too low.</p> <p>High limit switch tripped.</p> <p>Spa in wrong mode (economy).</p>	<p>Have checked by a qualified electrician.</p> <p>Turn temperature higher.</p> <p>Check display panel. Refer to Trouble Shooting Guide under Digital Controls.</p> <p>Put spa in correct mode.</p>
Does not heat to proper temperature.	<p>Spa cover left off.</p> <p>Did not allow adequate time for initial heating.</p> <p>Temperature too low.</p>	<p>Using spa cover when not in use will shorten the heating time.</p> <p>Allow adequate time for initial heating. Minimum 24 hours for 120V and 8 hours for 240V.</p> <p>Turn temperature higher.</p>
Pumps run, but won't prime. No water coming from jets.	<p>Air in filter system.</p> <p>Inlet or outlet valve closed.</p> <p>Impeller clogged.</p> <p>Water level too low.</p>	<p>Open bleeder valve at top of the filter canister until steady stream of water begins.</p> <p>Open valve.</p> <p>Contact your Morgan representative.</p> <p>Add water.</p>
Pump motor hums, but does not start.	<p>Binding of motor shaft .</p> <p>Improperly wired.</p>	<p>Contact your Morgan representative.</p> <p>Contact a qualified electrician.</p>
Noisy pump.	<p>Motor loose on mounting.</p> <p>Foreign material in pump.</p> <p>Impeller damaged.</p> <p>Worn bearings.</p>	<p>Tighten.</p> <p>Disassemble pump and clean. Contact your Morgan representative.</p> <p>Contact your Morgan representative.</p> <p>Contact your Morgan representative.</p>



SECTION 4 AIR CONTROLS, JETS & OTHER FEATURES

NOTE: Jets and valve styles shown **NOT** found in all models of spas.



Air Action Jet

This jet is powered by air and gives a bubbling action.



Air Injector Jet

This jet is powered by air and gives a unique bubbling sensation action.

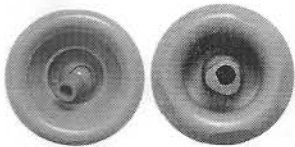

Large-Cyclone Mini-Cyclone Jets

This jet provides a truly remarkable and powerful massage by boasting a 360° circular motion and can be adjusted for pressure and direction.



Multifoot Massage Jet

Pressurized jet streams for a strong massage for your feet.



Ozone Jet

This jet serves as the entry point for your ozonator output which helps eliminate harmful microbes.



Flutter Blaster Jet (interchangeable with the Ultramassage Luxury Jet)

Flutter spinning motion gives a unique and pleasurable massaging sensation. Jets can be easily adjusted for water flow necessary for effective hydrotherapy by turning the jet face clockwise to reduce the water flow, or counter-clockwise to increase the water flow. To remove nozzle grab it with both index finger and thumb. While pulling out give nozzle a slight upward or downward motion. To install nozzle push nozzle into jet body until it locks in place.



Ultramassage Luxury Jet (interchangeable with the Flutter Blaster Jet)

This jet is adjustable. To adjust the luxury jets, turn the jet face clockwise to reduce the water flow, or counter-clockwise to increase the water flow. By moving the nozzle in the center, you can adjust the direction of the jets water flow. To remove the luxury nozzle turn the two tabs on either side of the nozzle counter-clockwise a quarter of a turn, then grab the inner nozzle and pull out. To install a luxury nozzle insert the nozzle all the way in and turn clockwise until it stops, which is the locked in position.



Volcano Jet

This jet provides a powerful surge from the footwell, which provides a reflexologic massage.



Mini-Flutter Blaster Jet

This jet gives has a unique flutter action that provides a tingling sensation similar to the large Flutter Blaster jet. Great adjustability helps you to select the hydrotherapy that fits your needs.



Mini-Luxury Directional Jet

This jet gives a massaging action similar to the full size Luxury Jet but with a smaller plume of water. Range of adjustability helps you customize your hydrotherapy by turning the jet face clockwise to reduce the water flow, or counter-clockwise to increase the water flow.



Non-Adjustable Pulsator Euro Jet

This jet has a unique spinning motion with a soft massaging action.



Non-Adjustable Directional Euro Jet

This jet has a unique soft massaging action. By moving the nozzle in the center you can adjust the direction of the jet water flow.

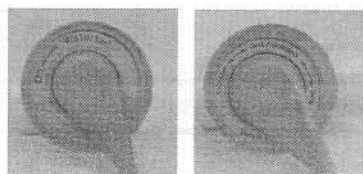

Power Collar Valve

This valve increases or decreases the water velocity to the mini-luxury jets in the power collar area. If your spa has a waterfall jet, then it will also have a Waterfall Power Collar Valve.

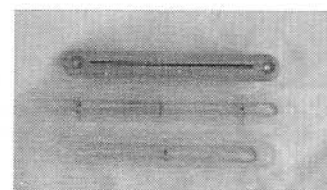

Waterfalls

Controlled by the On & Off Valve and is used to provide a soothing and relaxing atmosphere for your spa.

OTHER FEATURES

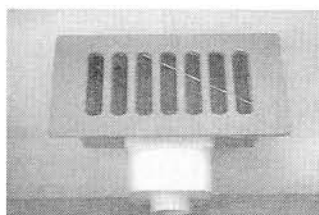

Box Skimmer W/Large Grate

The box skimmer is used to remove floating debris from the top of the water. In order to clean the skimmer basket, the front grate piece is slid upwards and removed to allow access to the floating door. The door is held down to gain access to the skimmer basket. This basket can then be removed and cleaned. Replacement of the basket is the same procedure as removing it. Note: The skimmer basket needs to be cleaned more frequently than the filter. (Note: Box skimmer is not found in all models of spas.)

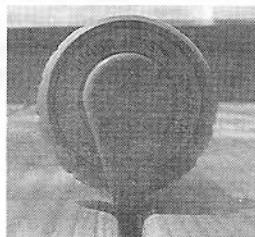

Air Controls

The air controls are found on the control panel and, on some models, along the top edge of the spa. These control the amount of air that is mixed with the water. The more air that is mixed in, the greater the jet action.

The different location of air controls enables you to vary the jet action in different areas of the spa at the same time. Note: it is a good habit to turn air controls off after each use of the spa.

There are two different methods to supply air to the jets to increase their action:

- » Turn on jet pump and turn controls counter-clockwise (to increase). The jets will create a natural air draw and increase the jet action.
- » Turbo charge – turn on the jet pump and blower, turn controls counter-clockwise to turbo jet. This will give you maximum jet action.

CAUTION: IF THE SPA IS LEFT IN BLOWER MODE ONLY AND THE TURBO CHARGER IS LEFT ON, YOU MAY EXPERIENCE SOME WATER SPLASHING OUT OF THE SPA.

On spa models with an infinite speed blower, by depressing the blower button you can control the turbo action by the jet.

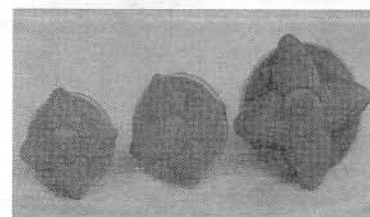

These are ONLY found in the Monaco 850 Series Spas

Air Control Valve

Moves more air to the other air controls for more power.

On & Off Valve

Turns the waterfall and neck jets on and off.

Volcano Divertor Valve

Operates the volcano jet. By turning it counter-clockwise it will increase the strength of the volcano jet.

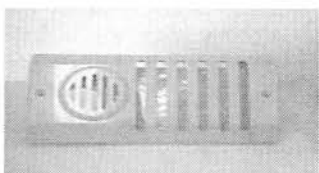

Strip Skimmer The strip skimmer is used to remove floating debris from the top of the water. The debris removed is sent through the filtering system and is caught in the filter cartridge itself.

SECTION 5 MAINTAINING YOUR PORTABLE SPA

Your Morgan spa, just like any other appliance, must be regularly maintained. Morgan recommends that the following maintenance and operation procedures be followed:

- » The filtration system of your spa should run at least 6 hours a day to keep the spa clean. These 6 hours required should be met at two different intervals of a 24 hour day with one interval being right after normal use of the spa.
- » The air blower should be used only when people are in the spa or adding chemicals. This will minimize heat loss and prevent unnecessary dissipation of chemicals.
- » Effective usage of your chemicals is determined by the pH of the water in your spa. Refer to your manual on testing procedure and how to use your test strips.
- » Refer to the manufacturer's direction on label regarding use of Morgan Shock-Out along with your Spa Frog In-Line System.

WARNING
CHECK WATER TEMPERATURE BEFORE ENTERING SPA.
WATER TEMPERATURE MUST NOT EXCEED 104° F.

RECOMMENDED MAINTENANCE SCHEDULE FOR YOUR SPA

The following directions are important for your reference in keeping your spa bright, clean and sanitary. Follow the Morgan Spa Maintenance Guide included with your spa. The following schedule is recommended to maintain your spa.

NOTE: Before each use add 1 tablespoon of Morgan Shock Out per every 250 gallons.

<p>Mondays –</p> <ul style="list-style-type: none"> ✓ Test pH levels. ✓ Adjust pH. Refer to chart in the Morgan Spa Maintenance Guide. ✓ Check bromine level and adjust if needed. ✓ Add 1 ounce of Spa Clear & Bright to your water. This will aid in the removal of both organic and inorganic suspended particles in the water. 	<p>Wednesdays –</p> <ul style="list-style-type: none"> ✓ Test pH levels. ✓ Adjust pH, if necessary. ✓ Check bromine level and adjust if needed. 	<p>Fridays –</p> <ul style="list-style-type: none"> ✓ Repeat Monday's program. ✓ Super oxidize the spa with Morgan Shock Out.
---	---	--

MAINTENANCE SCHEDULE

Usage	Clean Filter	Replace Bromine Cartridge	Replace Spa Frog Mineral Cartridge
1-3 uses weekly	Every 2 months	2-4 weeks *	Every 4 months
4+ uses weekly	Every month	2-3 weeks *	Every 4 months

(*Bromine cartridge replacement should be done when bromine level falls below recommended 1-2 ppm and you have physically removed and shaken the cartridge to verify it is empty. Remember the mineral cartridge must be replaced every 4 months and will always have spent material left when shaken.)

This schedule may vary depending on the use and care of your spa. Anytime the jet pressure decreases, immediately check and clean the filter. The above schedule represents an average spa with average usage. Under heavy usage you should check and make chemical additions to your spa more often than suggested.

We strongly recommend that you refer to the "Morgan Spa Maintenance Guide" included in your spa start-up kit for a better understanding of the spa chemicals and their use.

CLEANING & CHANGING FILTER CARTRIDGE & SKIMMER BASKET

The *top-load filter* is located under the small decorative cover on the top lip of the spa. **CAUTION: Do not try to remove the lock-ring or filter cap "manifold" before placing you spa in the stand-by mode.** Open the air relief valve.

Remove the lock-ring then remove the filter cap "manifold" by lifting or pulling on the handle. The cartridge filter can now be removed and cleaned by squirting in between the pleats with a garden hose. Rotate the cartridge housing from top down. After hosing the cartridge filter, allow the cartridge to dry and carefully brush the pleated surface area to remove the particles. Once cleaned, or new filter cartridge has been replaced and the manifold reinstalled, make sure the lock-ring has been installed properly and locked into place. **CAUTION:** Do not try to operate the spa without the filter or without replacing the lock-ring on the manifold. Trying to operate the spa with the manifold in place BUT without the lock-ring properly in place and locked may cause injury. **NOTE:** You should lubricate the o-ring with silicone-based lubricant (absolutely non-petroleum based), this will make installing much easier.

Algae, suntan oil and body oils form a coating on the cartridge pleats, which may not be thoroughly removed by housing. To remove such materials, spray the cartridge with Morgan Rapid Filter Rinse, which may be purchased at any Morgan spa sales location. Follow the directions on the label for use. After cleaning, hose the filter thoroughly before reinstalling. Depending on use and care, the filter cartridge should be cleaned monthly or more often with heavy use.

The **box skimmer** is used to remove debris from the water. This basket should be cleaned more frequently than the filter. In order to clean the skimmer basket, the front grate piece is slid upwards and removed to allow access to the floating door. The door is held down to gain access to the skimmer basket. This basket can then be removed and cleaned. Replacement of the basket is the same procedure as removing it.

The **strip skimmer** is used to remove debris from the water. The strip skimmer skims debris off the top of the water and sends it to the filter for collection.

HOW TO DRAIN & CLEAN YOUR SPA

NOTE: BEFORE draining water from spa you will need to turn off the main power supply.

The drain/fill valve is flush mounted in the kickplate, located on the same side as the equipment pack, secured in the closed position with a cap. This can be used to drain or fill spa.

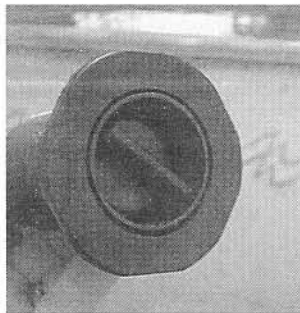

To drain spa pull the spout out all the way (approximately 2"), turning counter clock-wise while pulling out. This places spout in lock position so cap can be removed and garden hose attached.

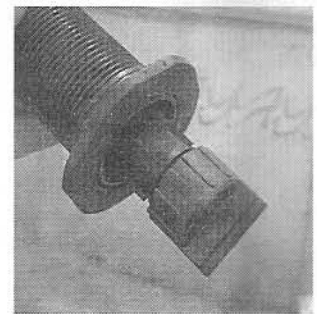

Once garden hose has been attached push the spout back in halfway to start water draining.

Note in first picture spout is pulled out all the way to attach hose and in second picture spout has been pushed back in halfway to allow water to drain.

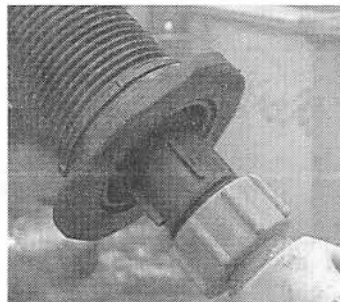

- ✓ You will need to allow approximately 3 hours for the spa to drain depending on its size. Any remaining water can be removed with a small plastic container.
- ✓ After you have washed out your spa, clean with an approved acrylic cleaner. Several brands are now on the market. Dry it with a clean non-abrasive cloth.

- ✓ Apply a layer of Morgan Quik Gloss to the acrylic surface. This will give a shiny, silky-smooth finish to your spa for added beauty and comfort.
- ✓ At this time you need to also clean or change the filter cartridge. Refer to section on "Cleaning and Changing Filter Cartridge."
- ✓ You may leave hose attached to the drain/fill valve to refill the spa. You will need to attach the other end of the hose to a faucet. REMEMBER – you will need to leave the spout pushed in halfway to fill spa.

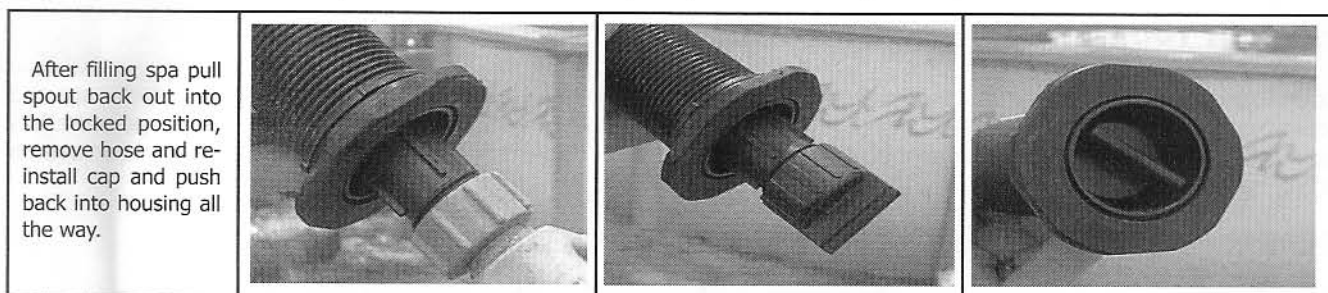

- ✓ Run in the high jet mode until you have good water circulation. Add chemicals and recommended amount of Metal Protector. Metal protector is very important in order to prevent calcium buildup. See section on "Initial Start-up."

CARE & UPKEEP

The Wood Cabinet

Morgan offers two choices of cabinets – Redwood or Synthetic.

- ✓ The *redwood cabinet* is stained with a water resistant sealer during the manufacturing process. To preserve the original beauty of the material and not void your warranty, you MUST re-treat your wood at least once each year. Wood cleaners and sealers with complete instructions are available from your local sales location.
- ✓ The *synthetic wood cabinet* is virtually maintenance free. Dust and dirt can be cleaned off with soap and water to maintain its appearance.

Acrylic Finish

Your spa is constructed of cross-linked acrylic, some of the most chemical resistant material available. However, care should be exercised not to drop objects or rub sharp objects on the surface as this may cause the material to be scratched.

If scratches do occur, a polishing compound (the kind most used on automobiles) can be used to remove them. Also, sanding with 600-grit wet/dry sandpaper lightly can remove these scratches. **CAUTION** should be exercised when sanding the surface. Morgan Quik Gloss will brighten the acrylic surface.

Damage to the spa surface caused by leaving the spa uncovered while either full of water or empty of water and in direct exposure to the sunlight (this may cause solar heating distress) are considered neglect care for the spa and will void the warranty on your spa. Such damage WILL NOT be covered by your warranty.

Spa Cover

Your Morgan spa is furnished with an attractive insulated vinyl cover. Two hold-down straps are manufactured into the spa cover. These buckles offer protection to secure the spa cover to the spa cabinet in windy conditions BUT are not intended to "child proof" the spa. Morgan does offer a locking strap for this intended purpose.

The cover is constructed of marine grade vinyl. Washing with a mild soap solution regularly will maintain the luster. Treat the spa cover with Morgan Spa Care Treat at least once every three months. This procedure can be done more frequently if needed.

Do not walk on your spa cover or allow children to play on top of it. It is not designed for use as a safety device and is not intended to hold weight.

Decks

A deck or patio around your spa can add real beauty and enjoyment. Contact your local Morgan sales representative for decking ideas and suggestions.

IMPORTANT NOTE — Be sure your patio has a slip resistant surface with adequate drainage. Check periodically for any signs of wear which may make these surfaces hazardous.

PROTECT YOUR SPA IN WINTER MONTHS

Cold climates, where the danger of freezing exists, require special care on your part in order to prevent damage to the spa and equipment. One feature of the Digital Control System is that it has freeze protection built in. When the water temperature falls below 40°F then the controller automatically activates the pumps to circulate the water. This is a normal spa function and no action on your part is necessary.

CAUTION – THE ABOVE WILL NOT WORK IF THERE IS A POWER FAILURE.

The only sure way to winterize your spa is to complete the following steps ***BEFORE*** you experience a power failure:

- ✓ Drain spa of all water.
- ✓ Run blower to clear air channels of water. Be sure pump and heater are not running.
- ✓ Remove any remaining water with a sponge.
- ✓ Remove drain plug from bottom of pump housing.
- ✓ Remove cartridge housing and cartridge filter, drain water and leave off.
- ✓ For the best protection, the power pack can be removed.
- ✓ If you cannot drain all of the water, especially from the air channels and the heater housing, a non-toxic anti-freeze, which can be purchased at any recreation vehicle supply center, should be added.

If the power is to be out for a considerable length of time, it is advised that you contact your nearest sales location for instructions on how to minimize damage to your spa. We recommend that you use and enjoy your spa during the winter months. This takes the worry out of freezing temperatures and gives you twelve months of spa enjoyment.

MOVING A MORGAN SPA

Your Morgan portable spa can be moved when you change your address or you simply want to change the location of the spa in your backyard. When moving a spa, care must be taken to block and level the spa at key bearing points. For this reason, Morgan personnel ***MUST*** move your spa for the warranty to remain in force.

RELOCATION and/or MOVING OF YOUR SPA BY PERSONS OTHER THAN MORGAN PERSONNEL WILL VOID THE WARRANTY ON YOUR SPA.

SECTION 6

SPA CARE / CHEMICAL MAINTENANCE / OZONATORS / SPA ACCESSORIES

REGULAR SPA CARE

- ✓ Run filtration system a minimum of 4 hours per day to maintain good water flow through the Spa Frog In-Line System.
- ✓ Regularly test water for pH, total alkalinity and bromine levels. Maintain a 1-2 ppm bromine level at all times.
- ✓ Shock the spa with Morgan Shock Out once a week or if the water looks hazy.
- ✓ Remember to replace your Spa Frog Mineral Cartridge every 4 months or whenever you drain and refill your spa. Replace Bromine Cartridge when empty or test falls below 1-2 ppm.
- ✓ Lubricate the o'ring (located around top of the cartridge holder) twice a year with a silicone lubricant.

NOTE: Once wetted the time released mineral coating of the product is effective up to 4 months. After that time even if you hear the spent media inside, it is no longer effective and **MUST** be replaced.

Your Morgan spa is not like a swimming pool. On a much smaller scale the temperature and bather load are different. The water in the spa must be treated with chemicals to prevent the growth of bacteria and fungi and the transmission of diseases.

NEVER USE SWIMMING POOL CHEMICALS IN YOUR SPA.

IMPORTANT NOTE — DO NOT USE THE BAQUASPA CLEANING SYSTEM IN YOUR SPA. This cleaning system can cause severe damage to your spa's plastic PVC plumbing.

WARNING — Do not store spa chemicals underneath the spa cabinet.

You should conscientiously follow the instructions provided concerning the chemical balance of the water in your spa. The following is a list of general tips on the use and storage of chemicals.

- ✓ Before using chemicals, **READ** the labels and directions carefully. Follow use instructions found on the labels.
- ✓ **KEEP ALL CHEMICALS OUT OF THE REACH OF SMALL CHILDREN.**
- ✓ **Store your spa chemicals in a clean, cool, dry well ventilated area preferably off the floor to prevent contamination from other materials.**
- ✓ Always add the chemicals directly to the spa water. Chemicals should be broadcast across the surface of the water or diluted and poured into the water with the spa operating on "BLOWER ONLY" or on "HIGH PUMP" if your spa is NOT equipped with a blower.
- ✓ **NEVER** add chemicals to the spa while people are using it.
- ✓ Carefully clean up any spilled chemicals with large amounts of water to dilute and wash away the chemicals.
- ✓ Since the chemistry of spa tub water changes very quickly, test the water in your spa with a test kit on a daily basis. Add the necessary chemicals according to the test results and chemical manufacturer's instructions.

THE IMPORTANCE OF CHEMICAL BALANCE

FAILURE TO MAINTAIN PROPER DISINFECTANT LEVEL AND pH BALANCE IN YOUR SPA AT ALL TIMES CAN CAUSE SEVERE PERMANENT DAMAGE TO YOUR SPA'S EQUIPMENT.

Spa chemicals serve a variety of functions in your spa. They purify and disinfect the spa water and they also help to prevent mineral build-up and damage to your spa's equipment. Please read the following paragraphs about spa chemical balance, and also read the Morgan Spa Maintenance Guide and be thoroughly familiar with it.

A SIMPLE OVERVIEW OF SPA CHEMISTRY AND DISINFECTING

The filtering action of your spa's equipment can effectively remove soil particles and other debris, but the addition of spa chemicals is required to disinfect your spa. Disinfecting can be accomplished by adding a germ-killing chemical, silver, which is contained in your Spa Frog Mineral Cartridge, to the spa water in sufficient strength to provide nearly instantaneous destruction of bacteria.

The disinfecting agents plus strong oxidizers like Morgan Shock Out have properties, which cause them to react with and destroy many foreign materials other than bacteria. Many of these materials, if not destroyed by oxidation, would impart undesirable characteristics to the water.

THE IMPORTANCE OF pH CONTROL

pH is one of the most important aspects of spa water chemistry, yet it is also the most misunderstood. Maintaining pH balance is important to the long life of your spa and to your personal comfort when using your spa. The relative acidity of water (pH) is measured on a scale of numbers ranging from 0 to 14. The mid-point of seven (7) is said to be precisely neutral, above which alkalinity becomes progressively greater.

Your spa water pH should always be maintained at a slightly alkaline condition of 7.2 – 7.6 on this scale. This level may be checked using chemical test strips which are available at your Morgan store. Refer to the Morgan Spa Maintenance Guide for information on using these test strips.

From the viewpoint of health and sanitation, the most serious effect of improper pH control is reduced efficiency of the disinfecting process. As pH rises above 8.0, the sanitation residual progressively weakens to the point at which it may be virtually useless for disinfecting and oxidation purposes.

It can surprise the new spa owner to discover that serious water problems can develop despite the fact that the filters are functioning properly and the disinfectant levels are testing at normal. In such cases, the problem can often be traced to the fact that the pH has been permitted to drift well into the undesirable zone above 7.6 or below 7.2.

NOTE — Read through the Morgan Spa Maintenance Guide thoroughly and follow the instructions given prior to using the spa.

OZONATORS

SANITIZING WITH OZONE

Your spa has an option of having an ozone generator installed. The use of ozone in addition to normal spa sanitizing will significantly reduce the amount of chemicals used. Some benefits are:

- ✓ It kills all known bacteria and viruses found in spas, hot tubs, and pools quickly and effectively and it makes your water sparkle.
- ✓ It is inexpensive and automatic.
- ✓ It does not discolor hair or cause dry skin and it does not irritate eyes or skin.
- ✓ It is safe for your spa and equipment.
- ✓ It eliminates cloudy water.
- ✓ It will not adversely affect the pH.
- ✓ It eliminates chlorine and bromine by-products and is environmentally safe.

SPA MAINTENANCE WITH OZONE

Ozone is a very effective natural water purifier that is lethal to bacteria, viruses, and contaminants without harming people and equipment. There are just a few rules that you should follow. Take the time to learn these simple rules and you will have no trouble maintaining a clear, clean spa.

Always maintain the following spa water operating parameters	
Total alkalinity	80 to 120 ppm
Ph	7.2 to 7.6

- ✓ Operate your spa Filtration Cycle for the minimum time according to the following chart. Note: Ozone is only produced in the filtration mode. Also, spa conditions can vary due to location and bathing load – adjust accordingly.

Gallons	Operating Time Per Day
Up to 250	4 to 6 hours
251 – 500	8 to 10 hours
Over 500	12 to 18 hours

- ✓ Total alkalinity is very important. If the spa water's total alkalinity is too low, the pH can change rapidly and maintaining the proper pH level will be difficult. Equipment will become corroded if the total alkalinity is too low. If the total alkalinity is too high, it will be very difficult to adjust the pH. In addition, scale will form on the walls of the spa and in the equipment if the total alkalinity is too high. The water's total alkalinity should be adjusted to the proper level BEFORE adjusting the pH. Check total alkalinity once a week and adjust to proper levels if necessary.
- ✓ Ozone does not have an effect on the spa water's pH. Bathers will have the most effect on the pH. It is therefore necessary to check the pH of your spa water twice a week and adjust it to the proper level.
- ✓ Follow the instructions regarding your Spa Frog Purifier. Refer to Section 6 for information about the Spa Frog.
- ✓ Filtration is critical to proper ozone operation and water purity. Because ozone purifies the water so completely, the filter gets dirty faster.
 - Clean the filter properly and often. It is a good idea to have an extra filter cartridge handy so you can take the time to clean the filter properly and thoroughly.
 - Algae, suntan oils, body oils, and other personal care products can form a coating on the cartridge surface that may not be removed thoroughly by rinsing with a hose. We recommend spraying the filter with Morgan Rapid Filter Rinse.
 - Carefully replace the cartridge element over the rod making sure it seats properly. It is important that all the filter seals and gaskets are in their proper positions. If the filter is not sealed properly, it cannot do its job.
 - Inspect the filter cartridge and housing regularly. Bad gaskets or a loose or cracked filter housing can result in cloudy and unpleasant smelling water.
- ✓ After heavy use (more than 2 people in the spa for longer than half an hour), the spa should be "shocked" with Morgan Shock Out treatment to rid the water of the extra contamination.
- ✓ If the pH is too high (over 7.6) or too low (under 7.2), the water may look cloudy or green. The water may also be irritating to the eyes. High or low pH can also cause damage to the spa's equipment or scale build-up on the walls and plumbing.

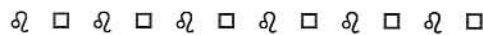

SPA ACCESSORIES

These accessory items are available through your Morgan representative:

- Complete line of chemicals*
- Replacement Filter Cartridges*
- Spa Cover Caddy*
- Ozonator*
- Spa Fragrances*
- Pillows*

Complete line of redwood products to include:

- Cabanas*
- Mood Rooms*
- Spazebos*
- Towel Bars*
- Steps*

Chemical Trouble-Shooting Guide

SYMPTOM	PROBABLE CAUSE	CORRECTIVE ACTION
Cloudy Water	Inadequate filtration / dirty filter	Check to make sure the filter is running properly; clean filter with Morgan Rapid Filter Rinse.
	Excessive oils / organic matter	Shock the spa with Morgan Shock Out.
	Improper sanitation	Shock the spa with Morgan Shock Out. Replace the Spa Frog Mineral Cartridge if older than 4 months.
	High pH and/or high alkalinity	Adjust pH using Morgan pH Down.
	Suspended particles / organic matter	Use Morgan Shock Out.
	High total dissolved solids (TDS)	Depending on the severity – drain the spa to half and refill; or drain the spa completely, clean and refill.
	Over used or old water	Drain the spa, clean and refill.
	Precipitated calcium	Use Morgan Metal Protector.
Water odor	Excessive organics	Shock the spa with Morgan Shock Out.
	Improper sanitation	Shock with Morgan Shock Out. Replace the Spa Frog Mineral Cartridge if older than 4 months.
	Inadequate filtration	Check to make sure the filter is operating properly, clean filter with Morgan Rapid Filter Rinse.
	Low pH	Raise the pH with Morgan pH Up.
Musty Odor	Bacterial or algae growth	Shock the spa with Morgan Shock Out. If problem visible, also drain, clean, refill and balance spa.
Foaming	Build up of body oils, lotion and chemicals resulting in soap or detergent	Add Morgan Foam Gone; or drain and refill.
	Over-used or old water	Drain and refill.
	Excessive organics	Shock with Morgan Shock Out.
	Improper sanitation	Shock with Morgan Shock Out. Replace the Spa Frog Mineral Cartridge if older than 4 months.
Organic Buildup	Body oils and dirt	Depending on severity – drain spa, use Morgan All Surface Cleaner to remove the scum, refill spa and adjust water.
	Inadequate filtration	Check to make sure the filter is operating properly. Clean filter with Morgan Rapid Filter Rinse. To clean the scum – drain spa, use Morgan All Surface Cleaner to remove scum, refill and adjust water.
Algae	High pH	Shock spa with Morgan Shock Out. Add Morgan pH Down.
	Insufficient sanitizing	Shock spa with Morgan Shock Out. Be sure the Spa Frog Mineral Cartridge is less than 4 months old. Replace if necessary.
Eye Irritation	Low pH	Raise pH with Morgan pH Up.
Skin Irritation	Unsanitary / polluted water	Shock spa with Morgan Shock Out. Replace the Spa Frog Mineral Cartridge if older than 4 months.
	Soaking too long	Soak for smaller intervals, such as 15 minutes.
	Water temperature too high	Reduce water temperature.
Stains	pH or total alkalinity too low	Adjust pH with Morgan pH Up and adjust alkalinity using Morgan Alkalinity Increaser. Also use Morgan Metal protector, drain and clean spa.
	High iron or copper in water source	Use Morgan Metal Protector; adjust water.
Scale	Too much calcium dissolved in water – pH and total alkalinity too high	Use Morgan Metal Protector; adjust alkalinity using Morgan pH Down. With concentrated scale deposits – drain the spa, scrub the scale off, refill the spa and balance the water.

GECKO SINGLE PUMP / DUAL PUMP 240

MAS-MSPA-MP P12-P21 DV-O-NE-A-1-LS-RTC-IR-RL-FB-MG
9660-01C



1-800-78-GECKO
INTL: 800-4328-8000

KEYPAD WITH DISPLAY

FIBER OPTIC

KEYPAD WITHOUT DISPLAY
(CABLE IS POLARISED)

TEMP PROBE

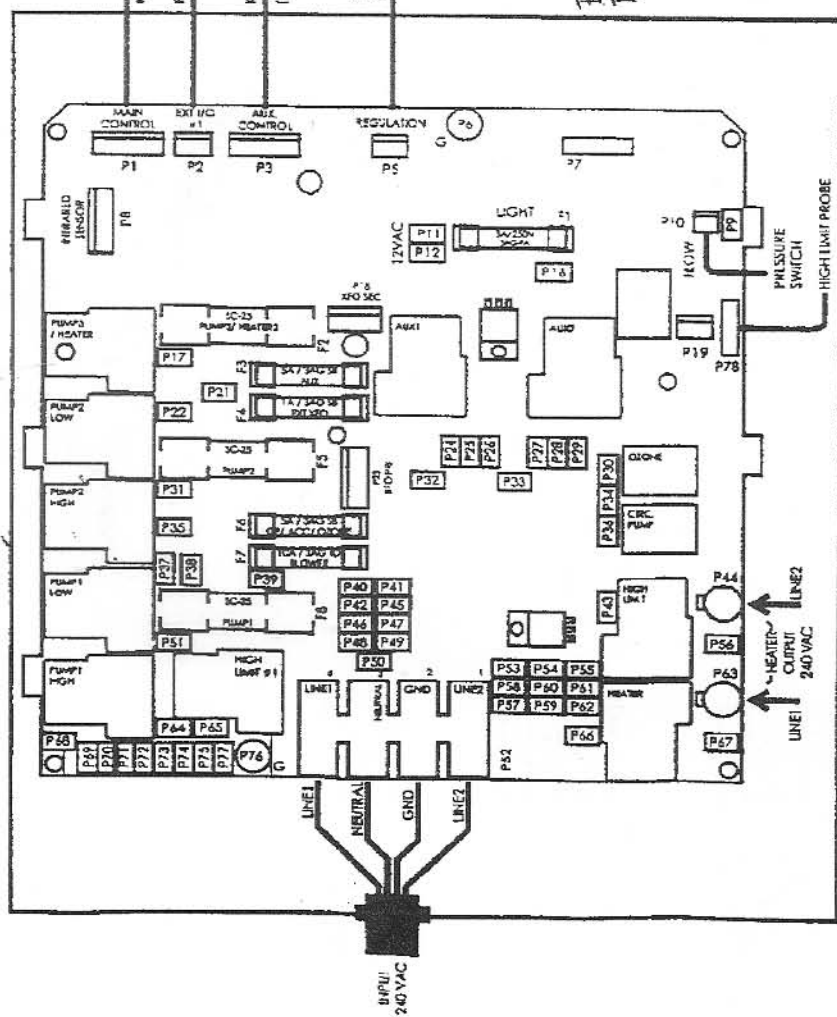

PUMP #1 CONNECTOR

VOLTAGE	240V/1
GREEN / GROUND	P69
BLACK / LOW SPEED	P37
BLACK / HIGH SPEED	P64
WHITE / COM	P57

PUMP #2 CONNECTOR

VOLTAGE	240V/1
GREEN / GROUND	P70
BLACK / HIGH SPEED	P35
WHITE / COM	P58

BLOWER CONNECTOR

VOLTAGE	240V/1
GREEN / GROUND	P72
BLACK / LINE	P43
WHITE / COM	P59

OZONE CONNECTOR

VOLTAGE	120V/1
GREEN / GROUND	P73
BLACK / LINE	P30
WHITE / COM	P46

ACCESSORY CONNECTOR

VOLTAGE	120V
GREEN / GROUND	P77
BLACK / LINE	P39
WHITE / NEUTRAL	P47

AUXILIARY LIGHT CONNECTOR

VOLTAGE	120V
GREEN / GROUND	P75
BLACK / LINE	P24
WHITE / NEUTRAL	P50

LIGHT CONNECTOR 24 W MAX.

BLACK/12VAC	P12
WHITE/0VAC	P16

HEATER

BLACK1	P63
BLACK2	P44
GREEN/GROUND	GROUND

GECKO 120 / 240 CONVERTIBLE PACK

PUMP #1 CONNECTOR

VOLTAGE	120V
GREEN / GROUND	P4
BLACK / LOW SPEED	P14
RED / HIGH SPEED	P12
WHITE / COM	P8

BLOWER CONNECTOR

VOLTAGE	120V
GREEN / GROUND	P6
BLACK / LINE	P11
WHITE / NEUTRAL	P9

OZONE CONNECTOR

VOLTAGE	120V
GREEN / GROUND	P5
BLACK / LINE	P16
WHITE / NEUTRAL	P8

LIGHT CONNECTOR

LIGHT	P23
WHITE / 0 VAC	P23
BLACK / 12 VAC	P22

PRESSURE SWITCH

(GREEN)	P25
(RED)	P24

HEATER 240V

BLACK 1	P20
BLACK 2	P21

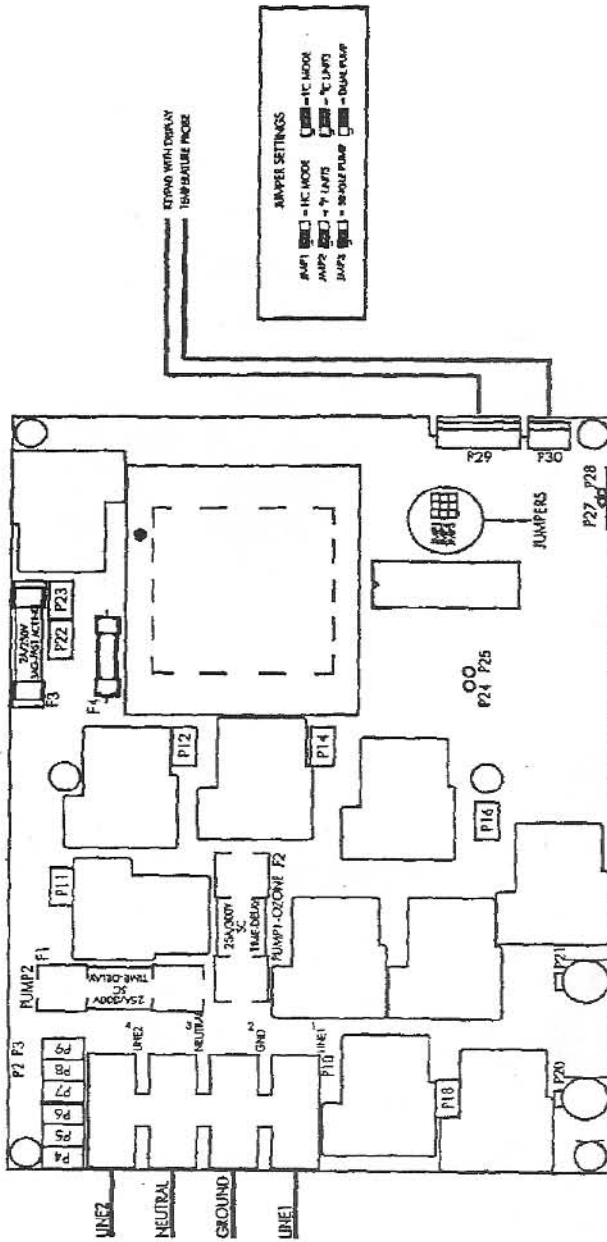

Use copper conductors **ONLY**. For supply connections,
Use conductors sized on the basis of 60°C ampacity
but rated Minimum 90°C.

GECKO 220V PACK NO BLOWER

PUMP #1 CONNECTOR

VOLTAGE	120V
GREEN / GROUND	P4
BLACK / LOW SPEED	P14
RED / HIGH SPEED	P12
WHITE / COM	P8

OZONE CONNECTOR

VOLTAGE	120V
GREEN / GROUND	P5
BLACK / LINE	P16
WHITE / NEUTRAL	P8

LIGHT CONNECTOR

LIGHT	P23
WHITE / 0 VAC	P23
BLACK / 12 VAC	P22

PRESSURE SWITCH

(GREEN)	P25
(RED)	P24

HEATER 240V

BLACK 1	P20
BLACK 2	P21

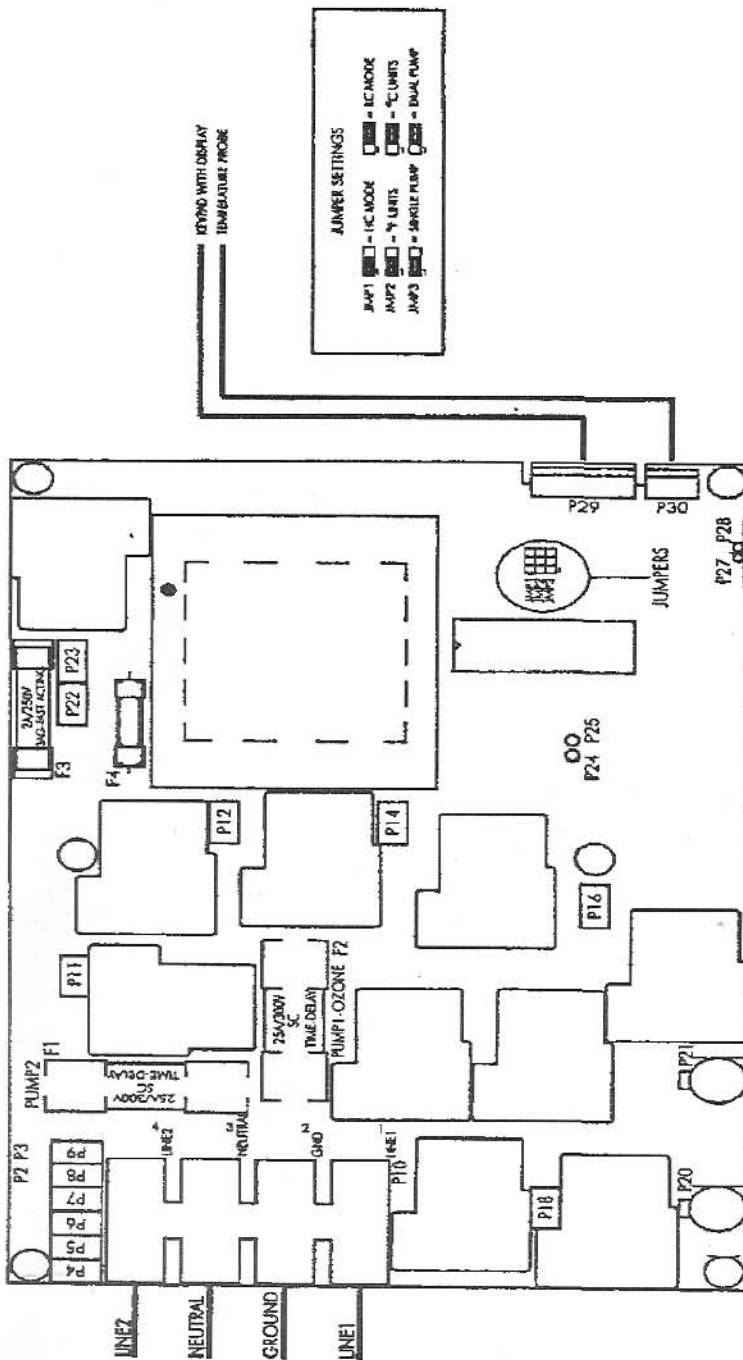

Use copper conductors ONLY. For supply connections,
Use conductors sized on the basis of 60°C ampacity
but rated Minimum 90°C.